

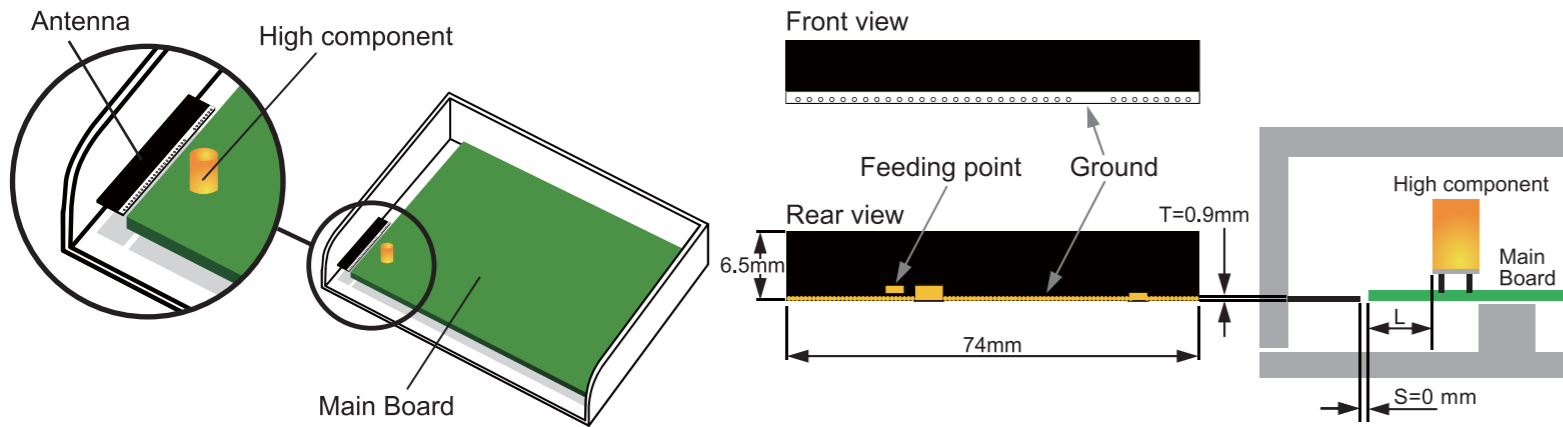

# Internal and External Antenna with Reliable Switch Bridge

## • Early-Stage Involvement Embedded Antenna Design

### 3G PCB Antenna Installation Study - 3G Penta Band



### Location Study

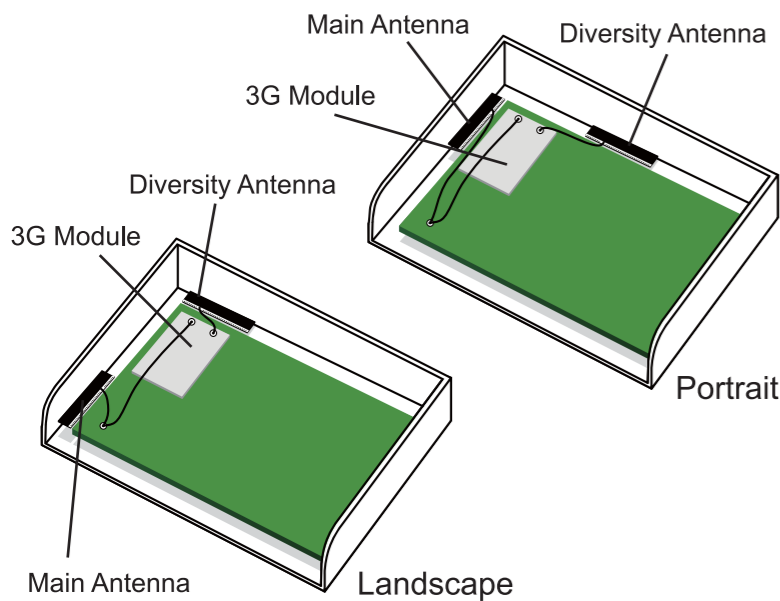

### Early Stage Involvement Mechanical / ID Design with Antenna Allocation Consideration

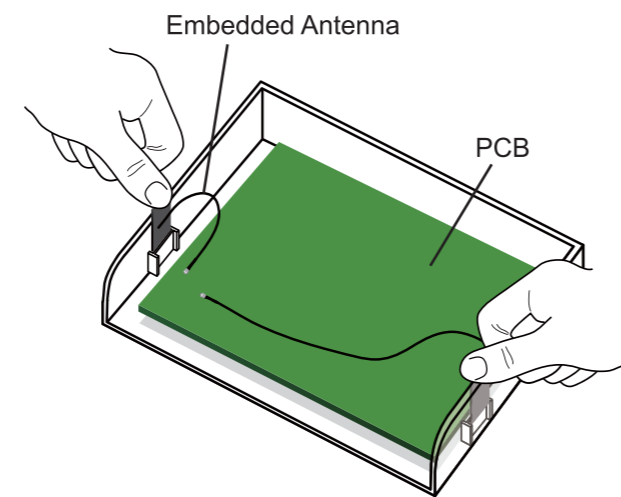

## • Reliable Internal & External Function Switch (RF switch)

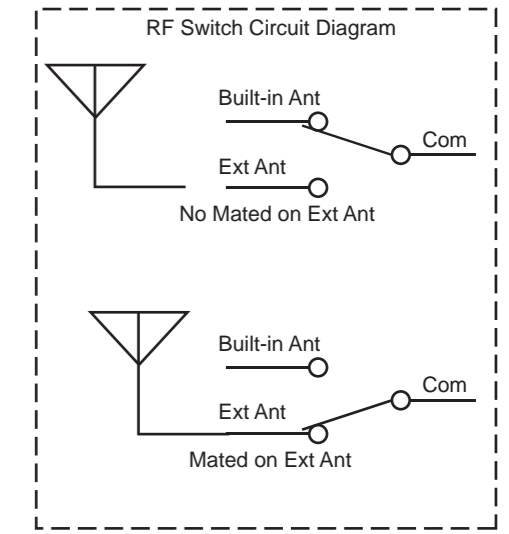
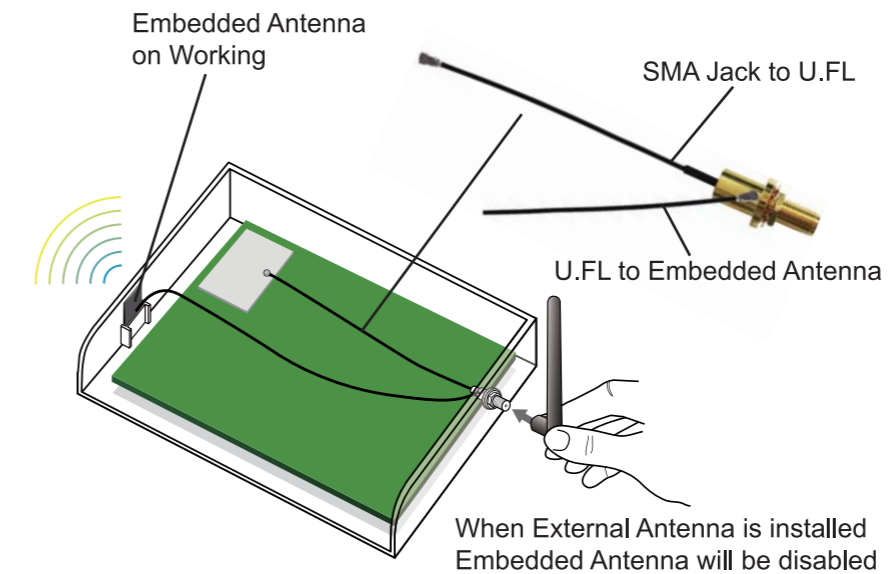

Cable Condition: OD1.37mm, 100mm

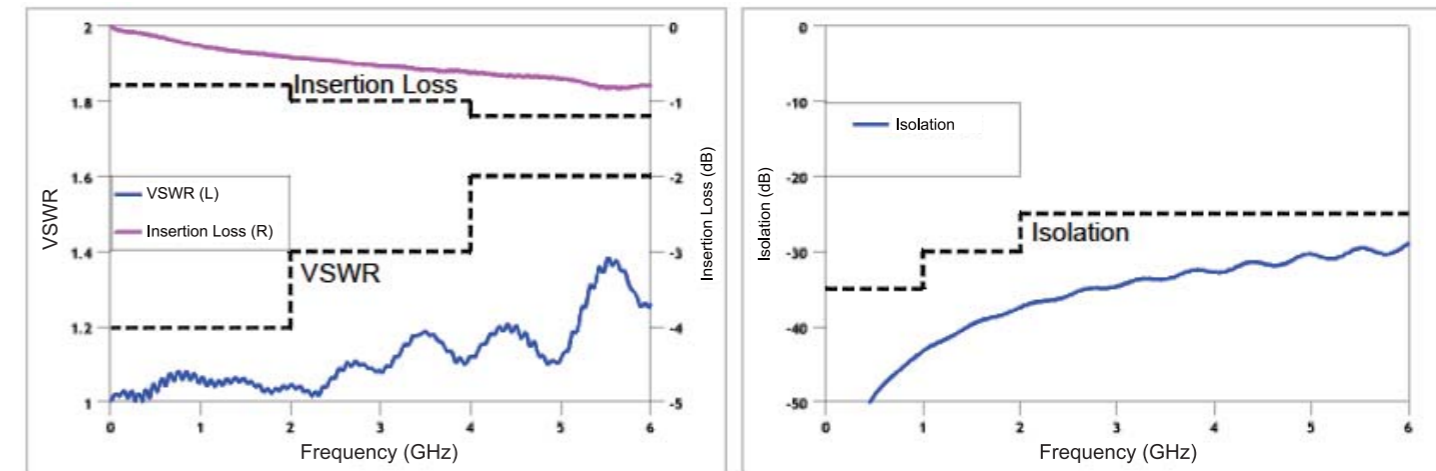

## • Dipole External Antenna



Stable Off-the-Shelf External Rod type Antenna with Water-proof version



### SMA

SMA B/H Jack Switch

R-S132G521-A



SMA B/H Jack Switch

R-S132G52-A



### RP-SMA

RP-SMA B/H Jack Switch

R-R132G521-A



RP-SMA B/H Jack Switch

R-R132G52-A

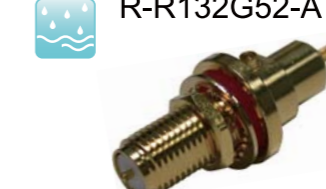

### N

N B/H Jack Switch

R-S632G52-A



• Design for Quality • Installation Friendly • Quick Time to Market